

**Thursday 26 May 2016 – Morning**

**GCSE MATHEMATICS A**

**A502/01** Unit B (Foundation Tier)

Candidates answer on the Question Paper.

**OCR supplied materials:**

None

**Other materials required:**

- Geometrical instruments
- Tracing paper (optional)

**Duration: 1 hour**

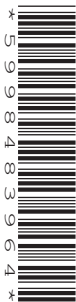

Candidate forename		Candidate surname	
--------------------	--	-------------------	--

Centre number						Candidate number				
---------------	--	--	--	--	--	------------------	--	--	--	--

### INSTRUCTIONS TO CANDIDATES

- Write your name, centre number and candidate number in the boxes above. Please write clearly and in capital letters.
- Use black ink. HB pencil may be used for graphs and diagrams only.
- Answer **all** the questions.
- Read each question carefully. Make sure you know what you have to do before starting your answer.
- Your answers should be supported with appropriate working. Marks may be given for a correct method even if the answer is incorrect.
- Write your answer to each question in the space provided. Additional paper may be used if necessary but you must clearly show your candidate number, centre number and question number(s).
- Do **not** write in the bar codes.

### INFORMATION FOR CANDIDATES

- The number of marks is given in brackets [ ] at the end of each question or part question.
- Your quality of written communication is assessed in questions marked with an asterisk (\*).
- The total number of marks for this paper is **60**.
- This document consists of **16** pages. Any blank pages are indicated.

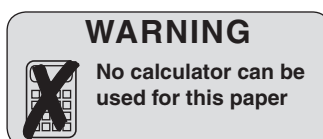

## Formulae Sheet: Foundation Tier

**Area of trapezium** =  $\frac{1}{2} (a + b)h$

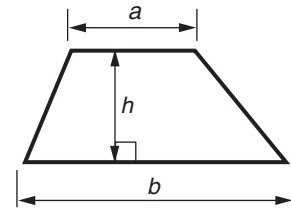

**Volume of prism** = (area of cross-section)  $\times$  length

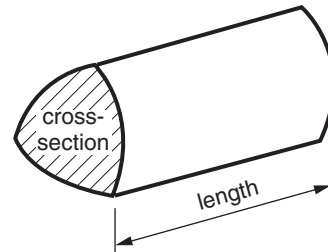

**PLEASE DO NOT WRITE ON THIS PAGE**

Answer **all** the questions.

- 1 (a) Work out.

$$\frac{1}{2} \times \frac{1}{8}$$

(a) ..... [1]

- (b) Work out.

$$\frac{1}{2} + \frac{1}{8}$$

(b) ..... [2]

- (c) Work out.

$$\frac{1}{2} \div \frac{1}{8}$$

(c) ..... [2]

- (d) Half of a circular cake is shared equally between 6 people.  
One of these six slices is shown shaded in the diagram.

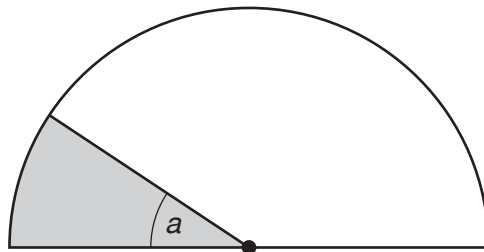

Not to scale

- (i) Work out the size of angle  $a$ .

(d)(i) ..... ° [2]

- (ii) Each slice is a fraction of the **whole** cake.

Write down this fraction.

(ii) ..... [1]

2 (a) The shape shown consists of four equilateral triangles and a square.

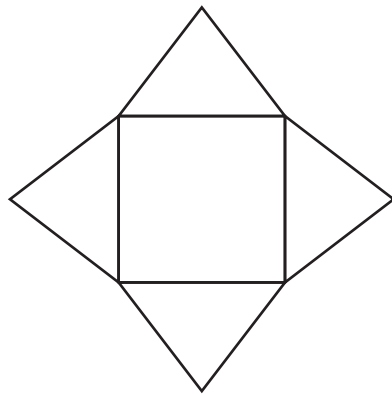

Not to scale

(i) Write down the order of rotational symmetry of the shape.

(a)(i) ..... [1]

(ii) On the shape above, draw all the lines of symmetry.

[1]

(iii) Work out the size of angle  $e$ .

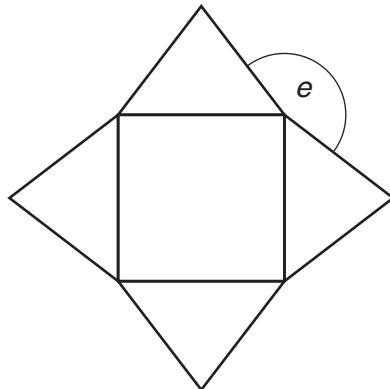

Not to scale

(iii) .....° [3]

(b) Select the mathematical name of a quadrilateral that has four equal sides but **is not** a square.

Draw a ring around the correct answer.

Rectangle

Parallelogram

Trapezium

Rhombus

Kite

[1]

- 3 (a) On Monday, Ruth's hens laid a total of 30 eggs.  
On Friday, Ruth said, 'My hens laid 10% more eggs today than they did on Monday.'

How many eggs did the hens lay on Friday?

(a) ..... [2]

- (b)\* One day, Ajit's hens laid a total of 18 eggs.  
The next day Ajit said, 'Today my hens laid exactly 20% more eggs in total than yesterday.'

Explain why Ajit's statement cannot be true, showing your working. [3]

- 4 This diagram shows two parallel lines with two lines crossing them.

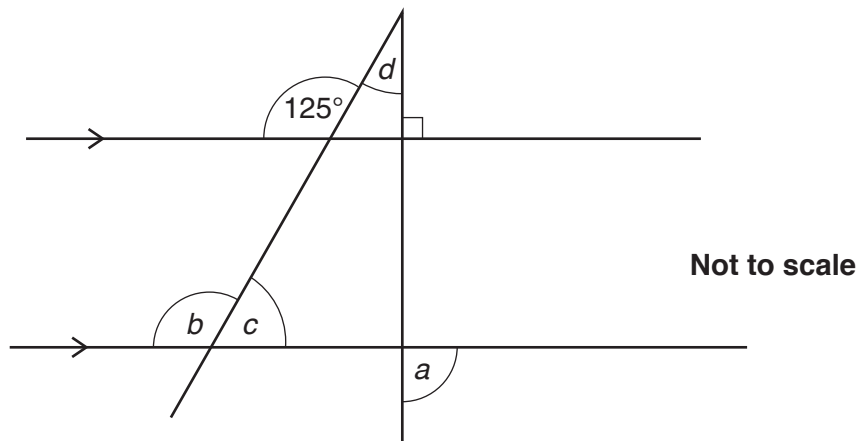

Find the size of

(a) angle  $a$ ,

(a) .....° [1]

(b) angle  $b$ ,

(b) .....° [1]

(c) angle  $c$ ,

(c) .....° [1]

(d) angle  $d$ .

(d) .....° [3]

- 5 This table shows the National Minimum Wage for 2011 to 2015.  
This wage is the smallest amount that a person of a particular age should be paid for each hour they work.

Dates	21 and over	18 to 20	Under 18
1st Oct 2014 – 30th Sept 2015	£6.50	£5.13	£3.79
1st Oct 2013 – 30th Sept 2014	£6.31	£5.03	£3.72
1st Oct 2012 – 30th Sept 2013	£6.19	£4.98	£3.68
1st Oct 2011 – 30th Sept 2012	£6.08	£4.98	£3.68

- (a) In November 2014, Gareth was 18 years old.  
He was paid the minimum wage.

How much was he paid for working 8 hours?

(a) £ ..... [2]

- (b) Zoltan has always been paid the minimum wage for his work.  
He had his 21st birthday on 1st October 2013.

Work out how much his hourly pay increased on his 21st birthday.

(b) £ ..... [3]

6 Triangle **P** is drawn on a grid.

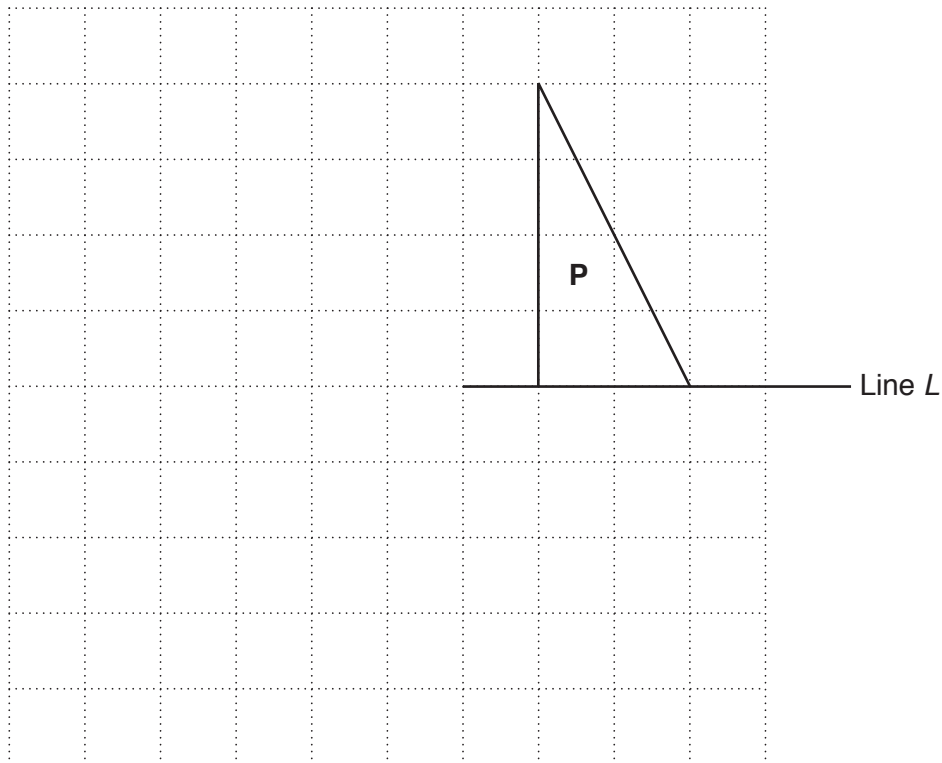

(a) On the grid, draw the reflection of triangle **P** in the line  $L$ . [1]

(b) On the grid, draw an enlargement of triangle **P** with scale factor 2. [2]

(c) Put a ring around the **one** property of triangle **P** that stays the same

- when triangle **P** is reflected in the line  $L$   
**and also**
- when triangle **P** is enlarged with scale factor 2.

Lengths

Angles

Areas

Perimeters

[1]



7 (a) Work out the value of  $2^2 \times 1^2$ .

(a) ..... [2]

(b) Complete the sentence below using one of these phrases.

square      positive square root      negative square root      cube      cube root

10 is the ..... of 100 [1]

(c)\* Liam says that 4 cubed divided by 4 squared is 1.5.

Is Liam correct?

Show clearly how you decide.

[3]

8 The *Tigers* rugby club provides bacon rolls on match days.

The organisers recorded how many bacon rolls they provided when different numbers of teams played.

<b>Number of teams</b>	4	4	5	6	6	6	9	9	11	12	12
<b>Number of bacon rolls</b>	60	65	95	84	93	120	153	117	176	156	206

The first 7 values are plotted on a scatter graph.

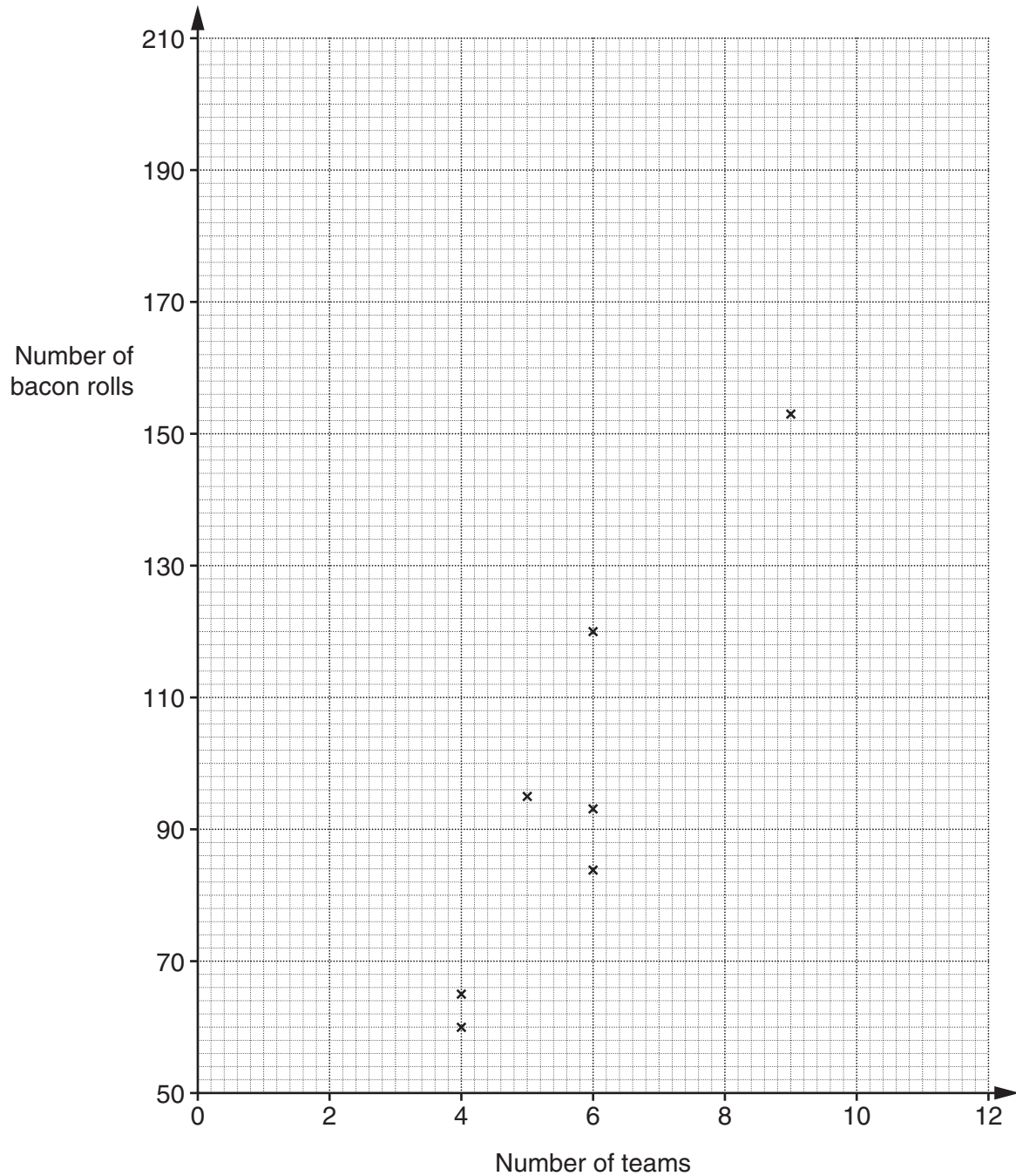

(a) Complete the scatter graph.

[2]

(b) What type of correlation is there between the number of teams and the number of bacon rolls?

(b) ..... [1]

(c) Draw a line of best fit on your scatter graph. [1]

(d) The club buys bacon rolls in packs of 6. Each pack costs £4.  
There are 8 teams playing on one match day.

Use your line of best fit to help you work out how much it costs the club to provide bacon rolls on that day.

(d) £ ..... [4]

- 9 (a) A plumber does three different tasks. She records the time each task takes and the amount she charges.

Task	A	B	C
Time taken ( $t$ hours)	1	3	7
Amount charged (£ $c$ )	60	140	300

Plot these values on the grid and draw a straight line through them.

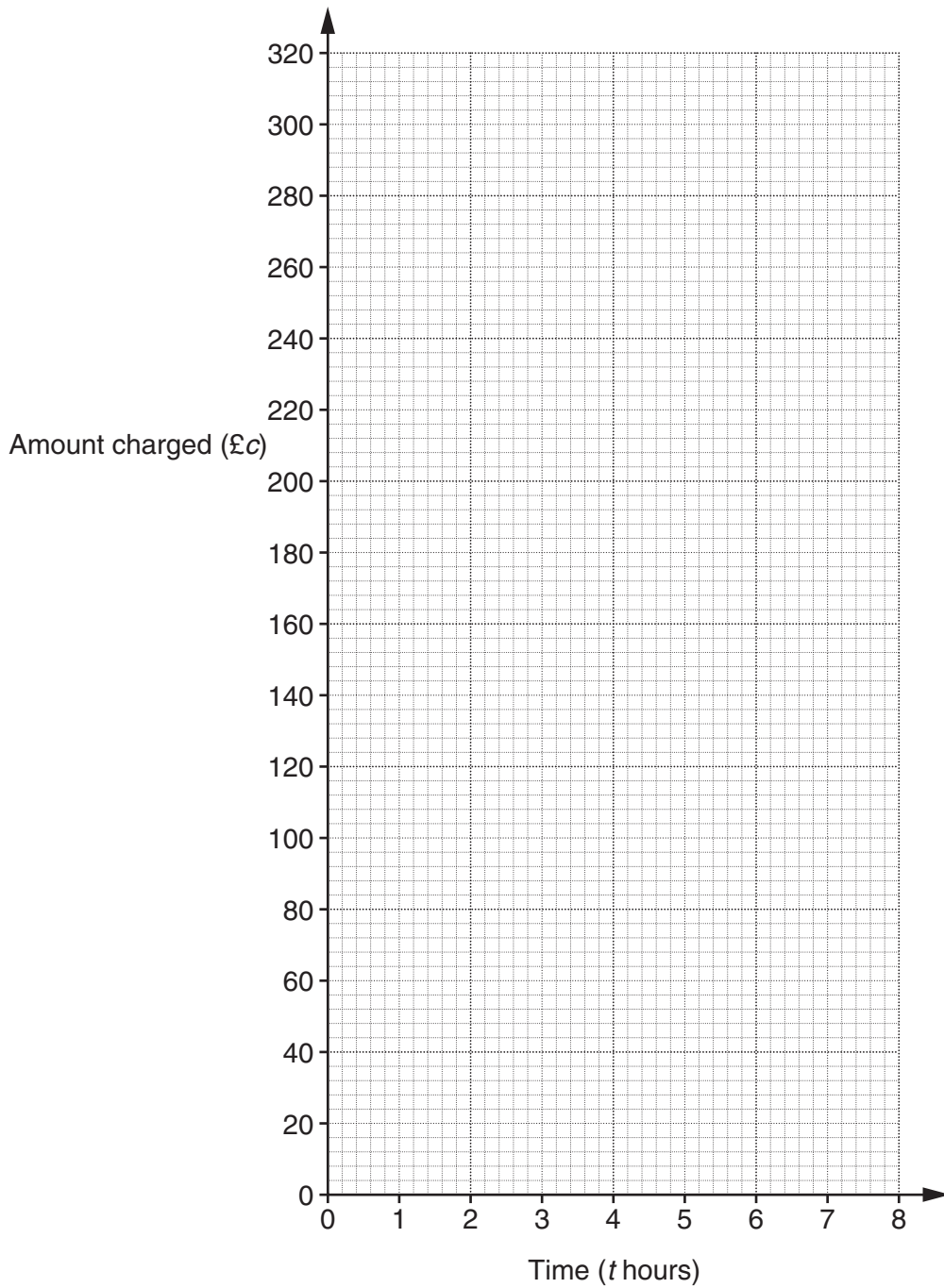

[2]

(b) The plumber charges a fixed call-out fee and an amount for each hour the task takes.

Complete the following.

The fixed call-out fee is £ .....

The amount for each hour is £ ..... [2]

(c) Use your answers to **part (b)** to work out the amount the plumber charges for a task that lasts 10 hours.

(c) £ ..... [2]

10 (a) A straight line is drawn on the grid.

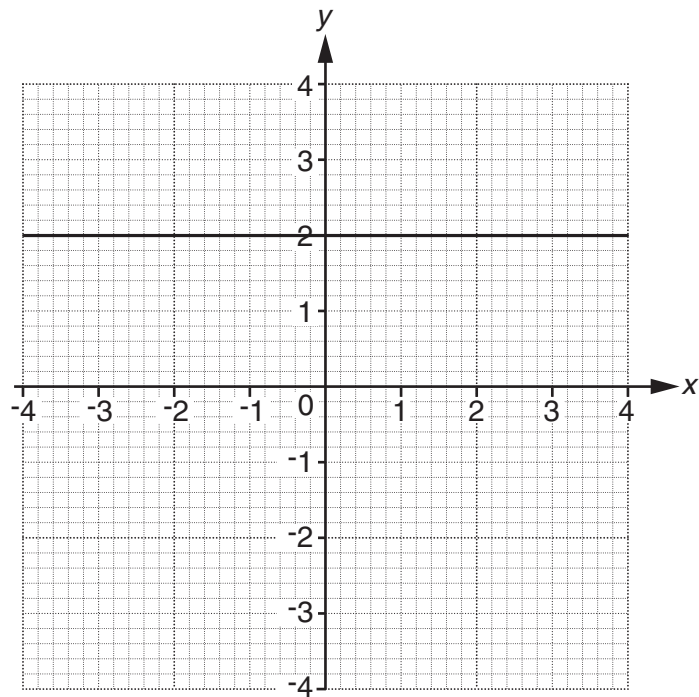

Write down the equation of this line.

(a) ..... [1]

(b) The line  $y = x - 1$  is drawn on this grid.

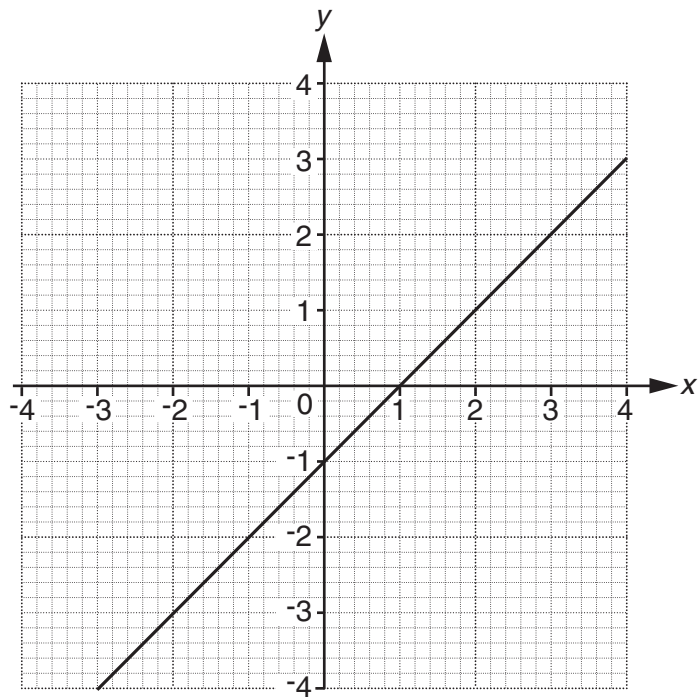

(i) Write down gradient of the line.

(b)(i) ..... [1]

(ii) The line  $y = x - 1$  passes through the point  $(a, 29)$ .

Find the value of  $a$ .

(ii) ..... [1]

(c) On the grid below, draw the line  $y = 2x - 1$  for values of  $x$  from  $-2$  to  $4$ .

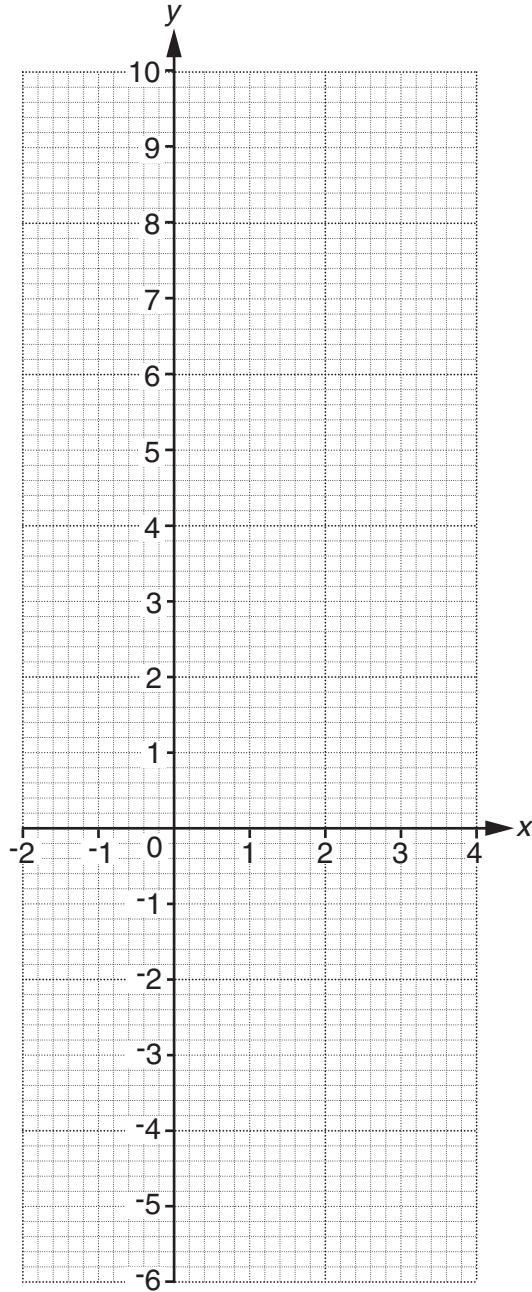

[3]

END OF QUESTION PAPER

**PLEASE DO NOT WRITE ON THIS PAGE**

---

**OCR**  
Oxford Cambridge and RSA

**Copyright Information**

OCR is committed to seeking permission to reproduce all third-party content that it uses in its assessment materials. OCR has attempted to identify and contact all copyright holders whose work is used in this paper. To avoid the issue of disclosure of answer-related information to candidates, all copyright acknowledgements are reproduced in the OCR Copyright Acknowledgements Booklet. This is produced for each series of examinations and is freely available to download from our public website ([www.ocr.org.uk](http://www.ocr.org.uk)) after the live examination series.

If OCR has unwittingly failed to correctly acknowledge or clear any third-party content in this assessment material, OCR will be happy to correct its mistake at the earliest possible opportunity.

For queries or further information please contact the Copyright Team, First Floor, 9 Hills Road, Cambridge CB2 1GE.

OCR is part of the Cambridge Assessment Group; Cambridge Assessment is the brand name of University of Cambridge Local Examinations Syndicate (UCLES), which is itself a department of the University of Cambridge.